

Modular Platform Components (MPC)

Surface-Mount Components, Substrates, Manifolds, Mounting Components, and Assembly Hardware

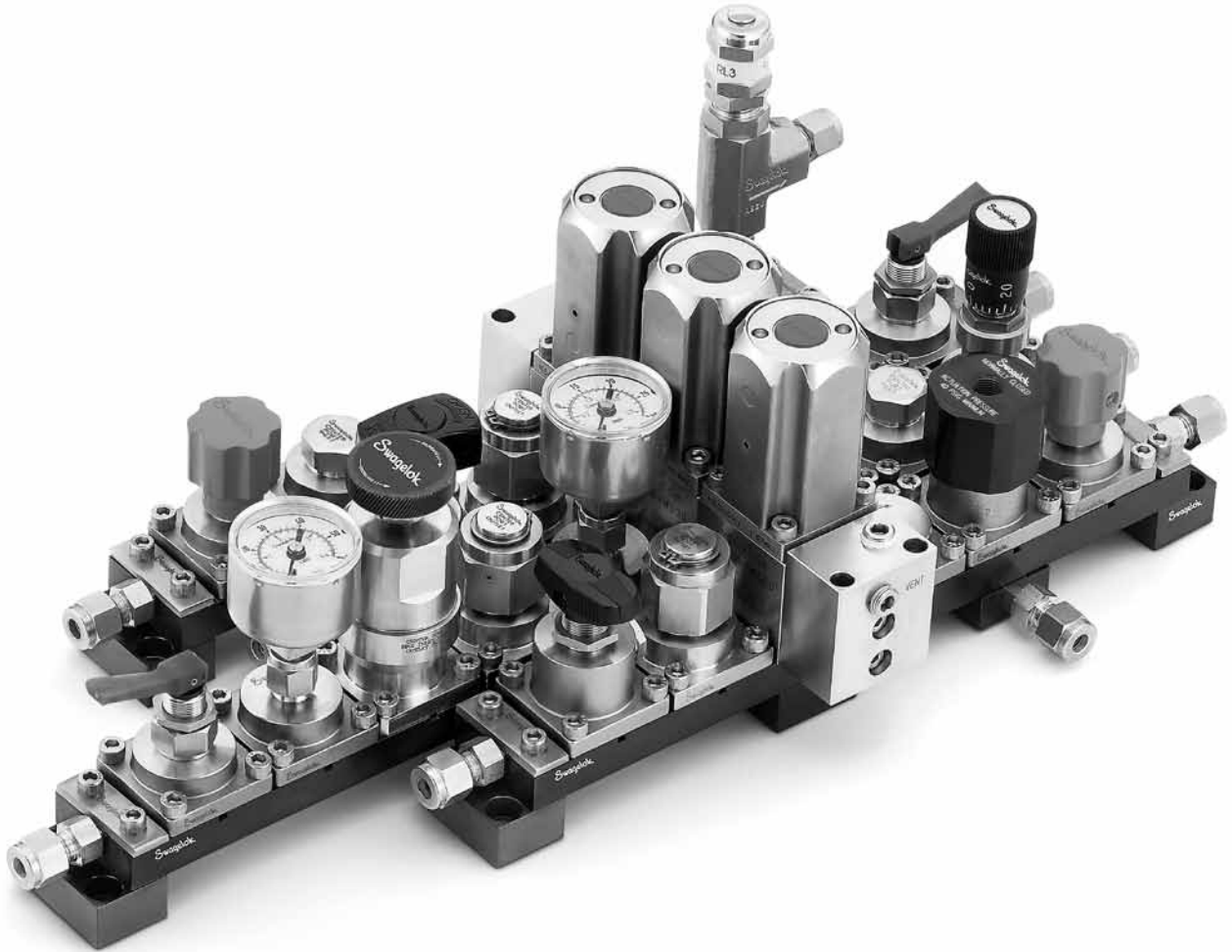

MPC Series

- ANSI/ISA 76.00.02-compliant design, 38.2 mm (1.5 in.) platform
- Easy to configure, assemble, and maintain
- Valves, filters, flowmeters, regulators, pressure gauges, and digital pressure-temperature transducers, as well as adapters for additional surface-mount components

Contents

Modular Platform Systems, 4

Typical Swagelok® MPC Assembly, 4

ANSI/ISA 76.00.02 Specification, 5

Technical Data, 5

Swagelok MPC Assembly Process, 6

Swagelok MPC System Configurator, 8

Swagelok Surface-Mount Components

Ball Valves, 42T Series, 9



Check Valves, CH Series, 10



Metering Valves, M Series, 10



Nonrotating-Stem Needle Valves, D Series, 11



Toggle Valves, OG Series, 11



Swagelok Surface-Mount Components

Pneumatically Actuated Shutoff Valves, T2A Series, 12



Pneumatically Actuated Switching Valves, PSV Series, 13



Proportional Relief Valves, R Series, 14



Springless Diaphragm Valves, DP Series, 15



Stream Selector Valves, SSV Series, 16



Contents

Swagelok Surface-Mount Components

Pressure Gauges, M Model, 17



Digital Pressure Transducers, PTX Series, 18



Variable Area Flowmeters, G2 Model, 19



Pressure-Reducing Regulators, KCP Series, 20



Swagelok Surface-Mount Components

Back-Pressure Regulators, KCB Series, 21



Tee-Type Filters, TF Series, 22



Surface-Mount Adapters, 23



Substrate Caps, 23

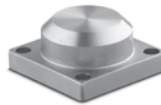

Surface-Mount Accessories

Electronic Position Sensors, 24



Digital Valve Control Modules, 25



Swagelok Substrate and Manifold Components

Substrate Channels, 26



Substrate Flow Components, 26



Manifold Flow Components, 28



Manifold Channels, 29

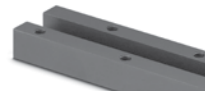

Seals, Mounting Blocks, Assembly Hardware, 30



Modular Platform Systems

The Swagelok modular platform component system is a system for use within process analyzer, sample-handling, and fluid distribution systems. The Swagelok MPC system includes a complete selection of MPC series components and a complementary configuration tool called the *MPC System Configurator* (page 8).

Swagelok Modular Platform Components

The components consist of a variety of Swagelok surface-mount components, which are ANSI/ISA 76.00.02-compliant, and a large selection of substrate and manifold flow components, which create the fluid distribution system.

Standard O-rings provide leak-tight seals between each surface-mount and substrate flow component and between the substrate and manifold flow components.

An MPC series assembly provides a compact fluid-distribution system with a reduced footprint for efficient use of component space. Modular technology allows the user to customize each system for a specific application and reduces installation and maintenance time. Surface-mount components can be serviced easily from the top of the assembly without disturbing any other components.

Surface-mount components, adapters, and caps are interchangeable on any surface-mount position because of the modularity of components and the use of the standard ANSI/ISA 76.00.02 interface.

Typical Swagelok MPC Assembly

The system below consists of a five-position assembly with a manifold layer assembled below Position 3. At this position, flow is diverted in two directions—up to the surface-mount component and down into the manifold layer.

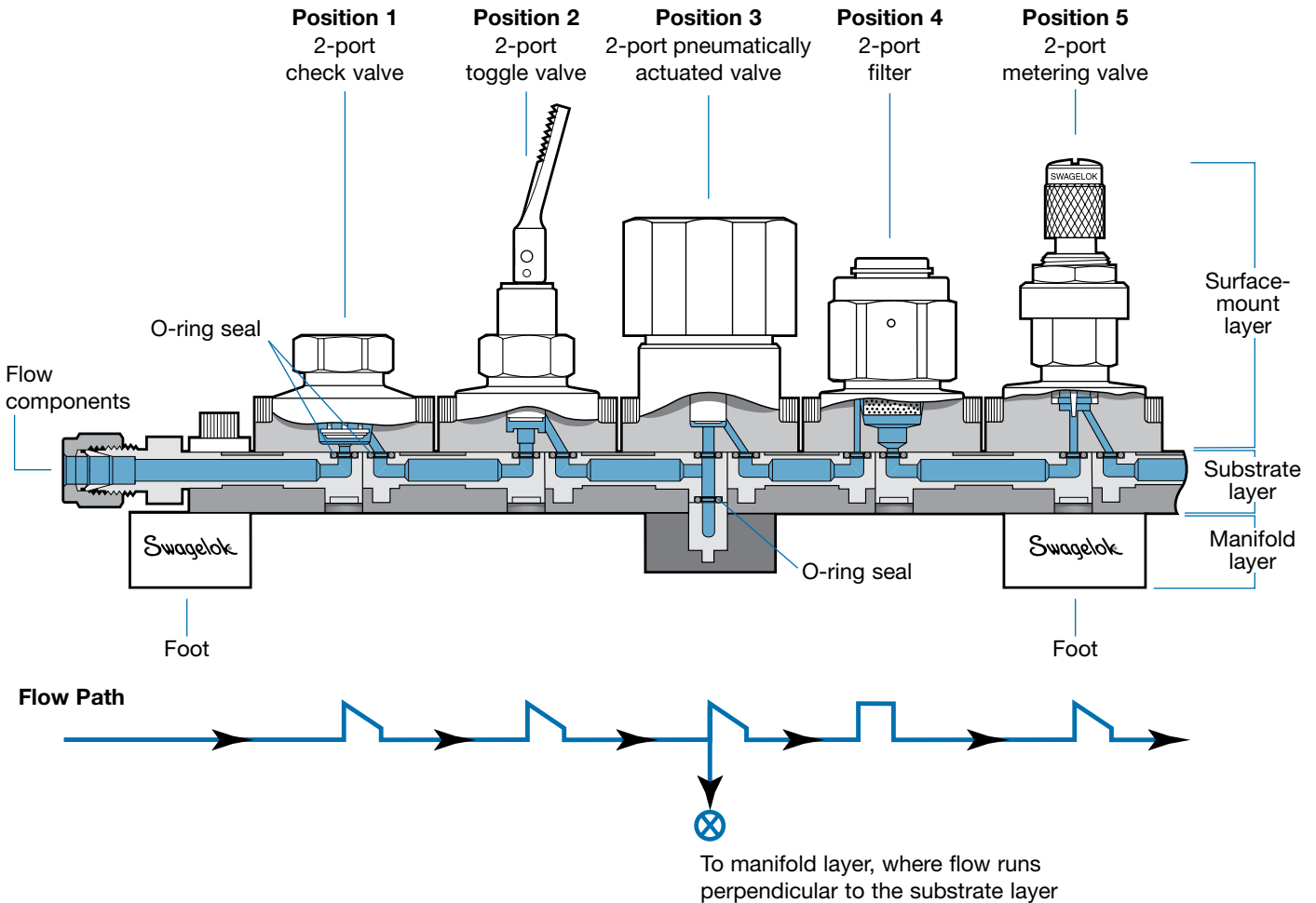

ANSI/ISA 76.00.02 Specification

Modular Component Interfaces for Surface-Mount Fluid Distribution Components

This specification establishes properties and physical dimensions that define the interface for surface-mount fluid distribution components with elastomeric sealing devices used within the process analyzer and sample-handling systems. The interface controls the dimensions and location of the sealing surfaces to allow changes of just one element of the system without modification of the entire system. This is what makes the system modular from both a design and a maintenance standpoint.

The Swagelok modular platform component system meets all the requirements of this specification for the 38.2 mm (1.5 in.) footprint. The standard dimensions of a typical Swagelok MPC series surface-mount component are shown at right.

38.2 mm (1.5 in.) Platform

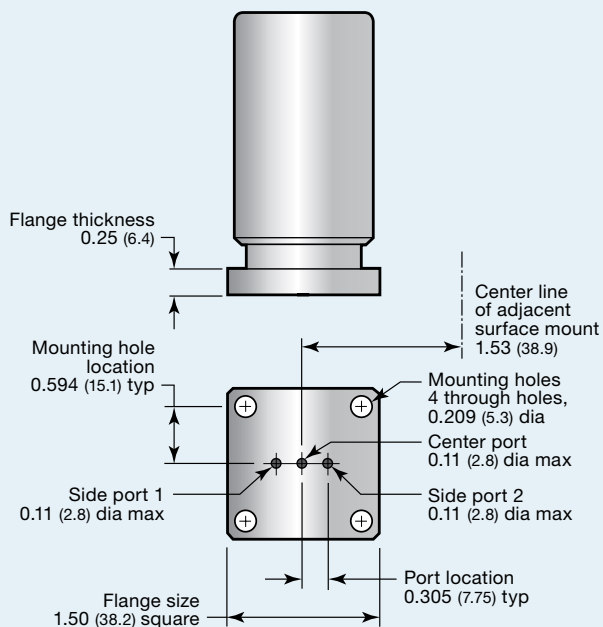

Dimensions are in inches (millimeters).

Technical Data

Pressure-Temperature Ratings

Surface-Mount Components

See specific component for pressure-temperature ratings.

Substrate and Manifold Components

Seal Material	Kalrez®	Fluorocarbon FKM
Temperature, °F (°C)	Working Pressure, psig (bar)	
20 (-6)	1000 (68.9)	3600 (248)
40 (4)	3600 (248)	3600 (248)
100 (37)	3600 (248)	3600 (248)
150 (65)	3320 (228)	3320 (228)
200 (93)	3040 (209)	3040 (209)
250 (121)	2786 (191)	2786 (191)
300 (148)	2115 (145)	2115 (145)

Materials of Construction

Surface-Mount Components

See specific component for wetted materials of construction.

Substrate and Manifold Components

- Wetted materials: 316L SS (ASTM A276 or A479) and fluorocarbon FKM or optional Kalrez
- Nonwetted materials: aluminum (alloy 2024-T351, hard-coat anodized) and 300 series stainless steel

Seals, Mounting Blocks, and Assembly Hardware

See page 30.

Testing

Surface-Mount Components

- Every Swagelok MPC surface-mount component is factory tested with nitrogen at 1000 psig (69 bar) or at its maximum working pressure if less than 1000 psig (69 bar). Seats have a maximum allowable leak rate of 0.1 std cm³/min. Shell testing is performed to a requirement of no detectable leakage with a liquid leak detector.
- Special testing options are available on request. Contact your authorized Swagelok representative.

Cleaning and Packaging

- All Swagelok MPC components are cleaned and packaged in accordance with Swagelok *Standard Cleaning and Packaging (SC-10)*, MS-06-62.
- Special cleaning options are available on request. Contact your authorized Swagelok representative.

Assembly Process

- For information on the assembly of Swagelok MPC components, see pages 6 and 7.
- For detailed assembly and service instructions, see *MPC Series Modular Platform Components Assembly and Service Instructions*, MS-12-39.

Swagelok MPC Assembly Process

A typical MPC system consists of three layers—a substrate layer, a manifold layer, and a surface-mount layer.

- The substrate layer provides flow through the system from one component to another.
 - The manifold layer provides flow from one substrate to another. Together, the substrate and manifold layers form the conduit for the system fluid, and they can be customized for any flow configuration.
 - The surface-mount layer provides shutoff, flow control, pressure regulating, and filtering capabilities for the system fluid.
- The complete MPC fluid system is assembled with simple mounting components and standard hardware.

Substrate Layer

The substrate layer provides the main flow path between the surface-mount components.

- The substrate layer consists of a **substrate channel** and a variety of drop-in **substrate flow components**.
- The substrate layer is built by aligning locator pins on the flow components into locating holes in the channel. This feature locks flow components into the channel, making assembly fast and error free.
- Substrate channels are available in a variety of lengths to accommodate up to 14 surface-mount positions.

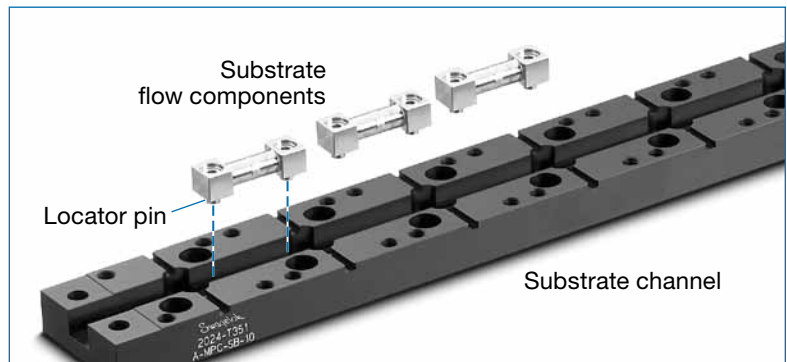

Manifold Layer

The manifold layer provides the flow path between two or more parallel substrates.

- The manifold layer consists of a **manifold channel** and a variety of drop-in **manifold flow components**.
- The manifold layer is also built with locator pins on the flow components that align in locating holes in the channel.
- Manifold channels are available in a variety of lengths to accommodate up to six parallel substrates.

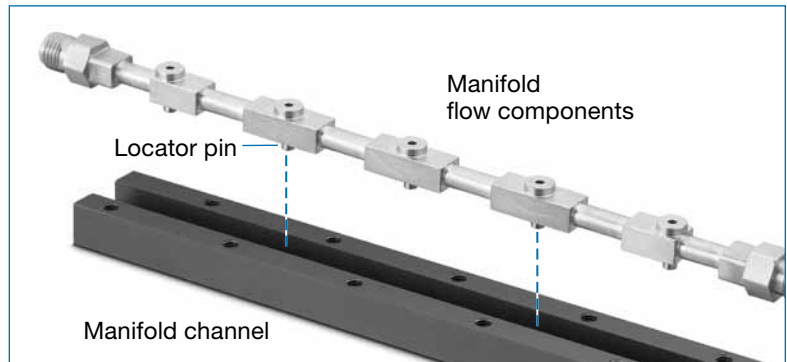

Substrate-Manifold Assembly

The **substrate layer** bolts over the **manifold layer** to create the substrate-manifold assembly.

- An O-ring (not visible) provides a leak-tight seal between the substrate and manifold layers.

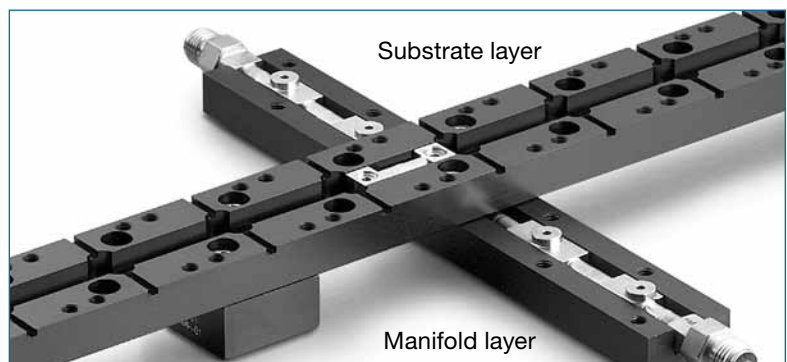

Swagelok MPC Assembly Process

Swagelok MPC Components

Swagelok **surface-mount components** are designed, manufactured, and tested to the same stringent quality requirements as conventional Swagelok fluid system components. They provide reliable Swagelok performance and value in a compact, ANSI/ISA 76.00.02-compliant interface.

Swagelok **substrate flow components** are made by butt welding two elbows together, eliminating entrapment zones and the need for O-ring seals between positions. This exclusive Swagelok design requires fewer O-ring seals than other modular platform systems, easing assembly and reducing the number of potential leak points.

Surface-Mount Layer

Surface-Mount Components

Surface-mount components, which feature all porting through a single surface, bolt to the top of the substrate-manifold assembly to complete the fluid system.

- **O-rings** provide leak-tight seals between surface-mount components and the substrate layer.
- Surface-mount components are available in a variety of shutoff, switching, metering, pressure regulating, and filtering styles with 2- or 3-port bodies.
- The porting and bolt pattern are open architecture, compliant with ANSI/ISA 76.00.02.

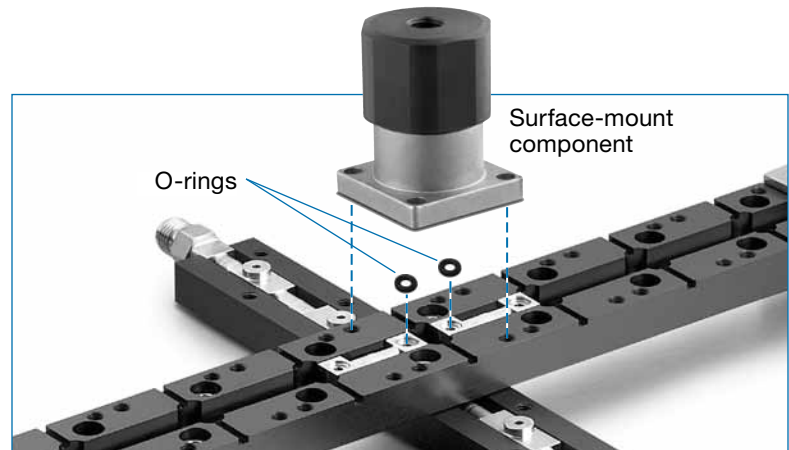

Surface-Mount Adapters and Caps

Adapters and **caps** are designed to bolt to the top of the substrate layer with the same footprint as a surface-mount component.

- **Adapters** provide a direct connection to the substrate layer and are available in several fitting styles and sizes to provide ANSI/ISA 76.00.02 interface for a variety of fluid control components.
- **Caps** cover and protect unused positions on the substrate layer.
- O-rings provide leak-tight seals.



Mounting Blocks

- **Feet** bolt to each end of the substrate layer, providing panel-mount capability.
- **Supports** bolt underneath the substrate layer, providing mid-line support for longer substrates.
- **Spacer feet** bolt two substrate assemblies together end to end, maintaining standard surface-mount spacing between them.

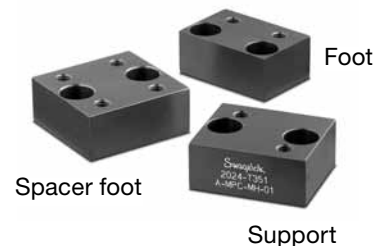

Swagelok MPC System Configurator

MPC system component selection and the assembly process are simplified with the use of the *MPC System Configurator*, a free Windows®-based software program that can be downloaded from www.swagelok.com. The *Configurator* allows the user to create a customized system by defining, placing, and connecting surface-mount components on a layout grid.

Once the layout is complete, the *Configurator* identifies the MPC series flow connectors (including substrates, manifolds, seals, and assembly hardware) that are necessary to build the complete system. A bill of material is generated for ease of ordering components, and schematics are produced to facilitate assembly. The *Configurator* also integrates with the user's AutoCAD® installation to create two-dimensional drawings and with the user's SolidWorks® installation to produce three-dimensional solid models.

Features

- Standard Windows menus and icon buttons
- Expandable grid for unlimited configurations
- Immediate output of standard fluid system calculations, such as pressure drop, flow rate, and Joule-Thomson cooling, based on a wide range of typical system gases and liquids
- Bill of material with itemized part numbers and assembly schematics that can be exported to a Microsoft® XPS document for easy file sharing
- Two-dimensional AutoCAD schematic and assembly files
- Three-dimensional SolidWorks models

For more information, contact your authorized Swagelok representative.

Configurator Bill of Material and Assembly Schematics Output

Swagelok MPC System Configurator

MPC Project Overview Page 1 of 5

MPC Project Name: Swagelok MPC System
 Author: SF
 Company Name: Swagelok
 Date: Friday, August 12, 2011
 Notes: Customer System 1

Combined Project Bill Of Materials

ID	Part	Description
1	A-MPC-MS-04	MANIFOLD CHANNEL, MPC, 1 POSITION
2	A-MPC-MS-04	SUBSTRATE CHANNEL, MPC, 4 POSITIONS
3	A-MPC-MS-04	SUBSTRATE CHANNEL, MPC, 1 POSITION
4	A-MPC-MS-08	SUBSTRATE CHANNEL, MPC, 8 POSITIONS
5	A-MPC-MS-08	MANIFOLD, MPC, BUSH, SWAGelok TUBE FITTING, 1 POSITION
6	A-MPC-MS-08	SUBSTRATE, MPC, SHIP DOWN CONNECTOR, SUBSTRATE TO MANIFOLD
7	A-MPC-MS-08	SUBSTRATE, MPC, CENTER, CENTER, 1/4" LONG
8	A-MPC-MS-08	SUBSTRATE END CONNECTOR, 1/4" SWAGelok TUBE FITTING, CENTER
9	A-MPC-MS-08	SUBSTRATE, MPC, SIDE, CENTER, 1/4" LONG
10	A-MPC-MS-08	SUBSTRATE END CONNECTOR, 1/4" SWAGelok TUBE FITTING, SIDE
11	A-MPC-MS-08	SUBSTRATE, MPC, SIDE, SIDE, 1/4" LONG
12	A-MPC-MS-08	SWAPER SUB CONNECTOR, MPC, 1 POSITION, SIDE, CENTER, 3/8" LONG
13	A-MPC-MS-08	WORKING FOOT, MPC
14	A-MPC-MS-08	SUPPORT FOOT, MPC
15	PC-20-MPC-026	ORING, RMA (30x30mm 100)
16	SS-MPC-MS-000	SOCKET HEAD CAP SCREW, 1/2-20 X 1.50 IN. (31.75mm 100)
17	SS-MPC-MS-000	SOCKET HEAD CAP SCREW, 1/2-20 X 1.00 IN. (25.4mm 100)
18	SS-MPC-MS-000	LOCKWASHER, MPC
19	PC-20-MPC-026	PRESSURE REGULATOR, COP, 100 PSI, 1/2 IN. (12.7mm) TO 1/4 IN. (6.35mm) 100 PSIG (6.9 bar)
20	PGI-40A-P010-CAG	PRESSURE GAUGE, 40A, PRIMARY, psi, SECONDARY, bar, 0 to 100 psi, 1/4 IN. TUBE FITTING
21	SS-MPC-MS-026	HANDLABLE VALVE, 400 SERIES, 2 PORT
22	SS-MPC-MS-026	TUBING, 1/2 IN. O.D., 1/8 IN. I.D., 1/4 IN. PORT SIZE
23	SS-MPC-MS-026	SURFACE MOUNT ADAPTER, 2 PORT, SWAGelok TUBE FITTING, 1/4 IN.
24	SS-MPC-MS-026	SEATING VALVE, 2 PORT, SLIDING HANDLE
25	SS-MPC-MS-026	SEAT WAX PRELUBRIC VALVE, COMMON, CENTER PORT
26	SS-MPC-MS-026	STREAM SELECTOR VALVE, 4 STREAMS, RMA SEALS

System 1 Schematic Diagram

Project

The diagram shows a complex fluid system layout on a grid. It includes a manifold at the top, multiple substrates, a pressure regulator, gauges, and various valves. The components are interconnected with tubing and fittings.

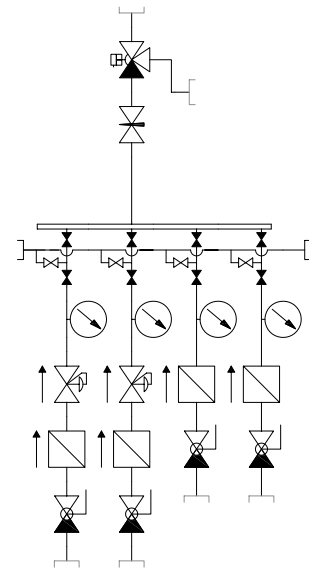

Two-Dimensional Schematic Output
(requires user's AutoCAD installation)

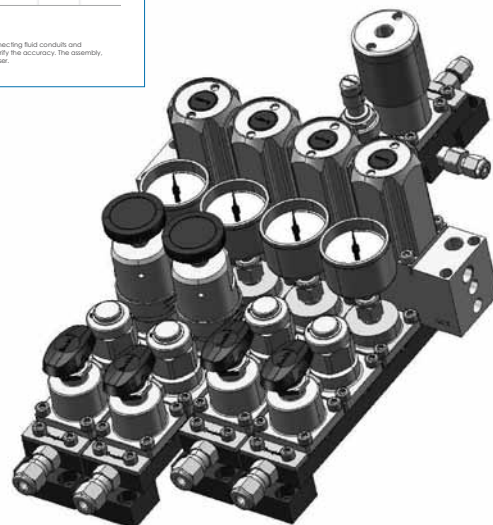

Three-Dimensional Model Output
(requires user's SolidWorks installation)

Swagelok Surface-Mount Components

Ball Valves, 42T Series

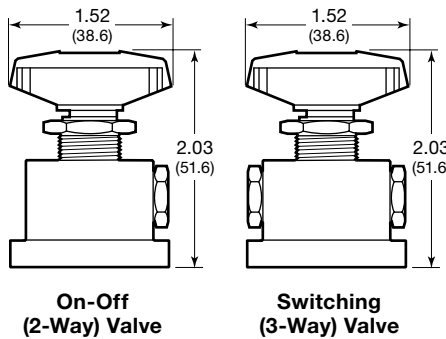

For additional information, see the Swagelok *One-Piece Instrumentation Ball Valves—40G Series and 40 Series* catalog, MS-02-331.

Features

- Pressure rating: 2500 psig (172 bar)
- Temperature rating: 20 to 150°F (–6 to 65°C)
- On-off (2-way) and switching (3-way) valves
- Flow coefficient:
 - 0.11, 2-way and 3-way common center port valves
 - 0.03, 3-way common side port valves
- Wetted components:
 - CF3M body
 - 316 SS ball stem
 - PFA packing
 - powdered metal 300 series SS side rings and side discs
 - fluorocarbon FKM or Kalrez side plug seal
 - silicone-based lubricant

Switching (3-Way) Valve Flow Paths

Common Center Port

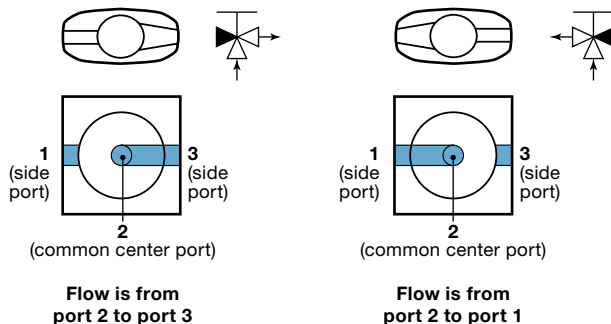

Common Side Port

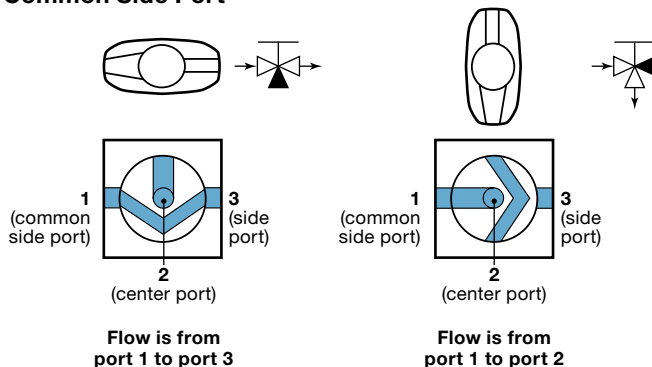

Ordering Information

Flow Configuration	Common Port	Ordering Number	Orifice in. (mm)
On-off (2-way)	—	SS-MPC-42T-2	0.090 (2.3)
Switching (3-way)	Center	SS-MPC-42XT-3	0.090 (2.3)
	Side	SS-MPC-42XTL-3-SC	0.040 (1.0)

Kalrez Seal Option

Kalrez material is available in place of fluorocarbon FKM side plug seal material. To order, add **-KZ** to the ordering number. Example: SS-MPC-42T-2-KZ

Swagelok Surface-Mount Components

Check Valves, CH Series

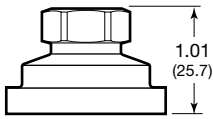

For additional information, see the Swagelok *Check Valves—C, CA, CH, CP, and CPA Series* catalog, MS-01-176.

Features

Pressure-Temperature Ratings

Seal Material	Fluorocarbon FKM
Temperature °F (°C)	Working Pressure psig (bar)
0 (-17) to 100 (37)	3600 (248)
150 (65)	3320 (228)
200 (93)	3040 (209)
250 (121)	2786 (191)
300 (148)	2115 (145)

- Flow coefficient: 0.09
- Wetted components: CF3M body; 316 SS poppet and poppet stop; 302 SS spring; fluorocarbon FKM seals
- Cracking pressure: 0 to 3 psi (0 to 0.20 bar); minimum reseal pressure: 6 psi (0.41 bar) back pressure

Ordering Information

2-Port Valve	3-Port Valve
SS-MPC-CH4-2	SS-MPC-CH4-3

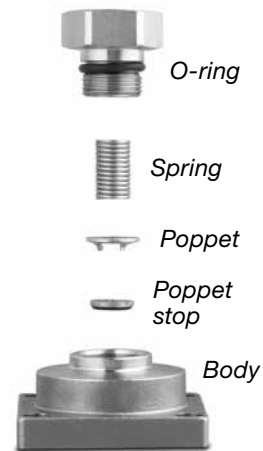

Kalrez Seal Option

Kalrez material is available in place of *wetted* fluorocarbon FKM seal material. To order, add **-KZ** to the ordering number.

Example: SS-MPC-CH4-2-**KZ**

Metering Valves, M Series

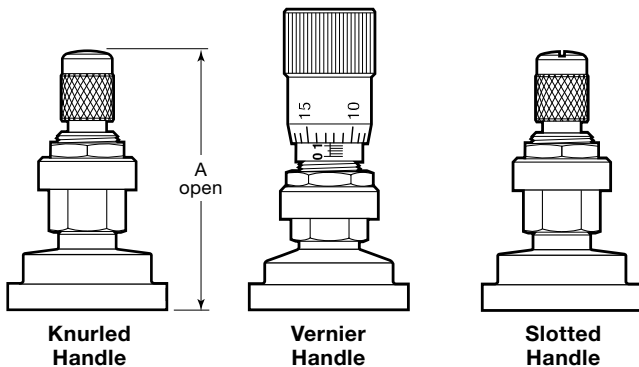

Features

- Pressure rating: 1000 psig (68.9 bar)
- Temperature rating: 0 to 300°F (-17 to 148°C)
- Flow coefficient: 0.03 max
- Wetted components: CF3M body; 316 SS stem; fluorocarbon FKM stem seals
- Knurled, vernier, and slotted handles available

Ordering Information

Handle	2-Port Valve	3-Port Valve	A, in. (mm)
Knurled	SS-MPC-M-2	SS-MPC-M-3	2.65 (67.3)
Vernier	SS-MPC-M-2-MH	SS-MPC-M-3-MH	3.24 (82.3)
Slotted	SS-MPC-M-2-SL	SS-MPC-M-3-SL	2.65 (67.3)

Kalrez Seal Option

Kalrez material is available in place of *wetted* fluorocarbon FKM seal material. To order, add **-KZ** to the ordering number.

Example: SS-MPC-M-2-**KZ**

For additional information, see the Swagelok *Metering Valves—S, M, L, and 31 Series* catalog, MS-01-142.

Swagelok Surface-Mount Components

Nonrotating Stem Needle Valves, D Series

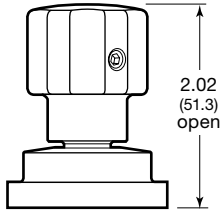

For additional information, see the Swagelok *Nonrotating Stem Needle Valves—D Series* catalog, MS-01-42.

Features

Pressure-Temperature Ratings

Stem Tip Material	PCTFE	PEEK
Temperature °F (°C)	Working Pressure psig (bar)	
0 (-17) to 100 (37)	3000 (206)	3000 (206)
150 (65)	2790 (192)	2790 (192)
200 (93)	2580 (177)	2580 (177)
250 (121)	—	2455 (169)
300 (148)	—	2115 (145)

- Flow coefficient: 0.10
- Wetted components: CF3M body; 316 SS stem; fluorocarbon FKM stem seal; PCTFE or PEEK stem tip
- Nonrotating stem provides repetitive shutoff.

Ordering Information

Stem Tip	2-Port Valve	3-Port Valve
PCTFE	SS-MPC-ODK-2	SS-MPC-ODK-3
PEEK	SS-MPC-ODP-2	SS-MPC-ODP-3

Handle Color Option

Color	Designator
Blue	-BL
Green	-GR
Orange	-OG
Red	-RD
Yellow	-YW

Standard handle color is black. To order an optional color, add a color designator to the ordering number.

Example: SS-MPC-ODK-2-YW

Visual Indicator Option

An optional **red band** under the handle provides visual indication of the *open* position. To order, add **-PI** to the ordering number.

Example: SS-MPC-ODK-2-PI

Kalrez Seal Option

Kalrez material is available in place of *wetted* fluorocarbon FKM seal material. To order, add **-KZ** to the ordering number.

Example: SS-MPC-ODK-2-KZ

Multiple Options

Add designators in *alphabetical* order.

Example: SS-MPC-ODK-2-KZ-PI-YW

Toggle Valves, OG Series

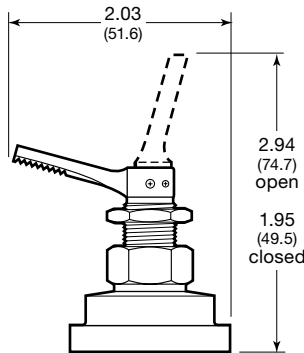

For additional information, see the Swagelok *Toggle Valves—OG and 1G Series* catalog, MS-01-54.

Features

- Pressure rating: 300 psig (20.6 bar)
- Temperature rating: 0 to 200°F (-17 to 93°C)
- Flow coefficient: 0.11
- Wetted components: CF3M body; 316 SS stem; PTFE stem tip; fluorocarbon FKM stem seal
- Toggle handle is rotatable to desired position.
- Handle positioner option allows fixed positioning of handle.
- Spring-return pin option helps prevent handle from being locked open.

Ordering Information

2-Port Valve	3-Port Valve
SS-MPC-OG-2	SS-MPC-OG-3

Handle Color Option

Color	Designator
Blue	-BL
Green	-GR
Orange	-OG
Red	-RD
Yellow	-YW

Standard handle color is black. To order an optional color, add a color designator to the ordering number.

Example: SS-MPC-OG-2-RD

Handle Positioner Option

To order, add **-TGP** to the ordering number.

Example: SS-MPC-OG-2-TGP



Spring-Return Pin Option

To order, add **-SPR** to the ordering number.

Example: SS-MPC-OG-2-SPR

Kalrez Seal Option

Kalrez material is available in place of *wetted* fluorocarbon FKM seal material. To order, add **-KZ** to the ordering number.

Example: SS-MPC-OG-2-KZ

Multiple Options

Add designators in *alphabetical* order.

Example: SS-MPC-OG-2-GR-KZ-TGP

Swagelok Surface-Mount Components

Pneumatically Actuated Shutoff Valves, T2A Series

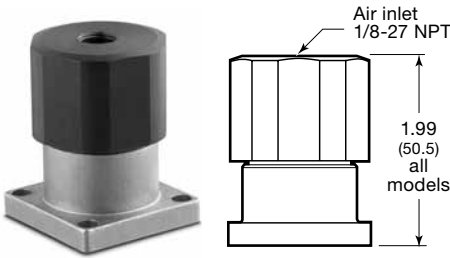

Features

- Flow coefficient: 0.07
- Wetted components: CF3M body; 316 SS stem; fluorocarbon FKM seals
- Optional indicator switch and visual indicator for normally closed valves

Pressure-Temperature Ratings

Actuation Mode	Working Pressure psig (bar)	Temperature °F (°C)	Actuator Pressure psig (bar)
Normally closed	125 (8.6)	0 to 300 (-17 to 148) ^①	40 to 100 (2.8 to 6.8)
Normally open	125 (8.6)		40 to 100 (2.8 to 6.8)
	300 (20.6)		65 to 100 (4.5 to 6.8)

① Cycle life may be reduced when operated below 20°F (-6°C).

Normally Closed Model

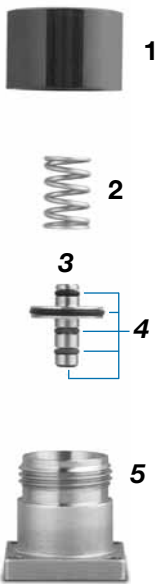

Normally Open Model

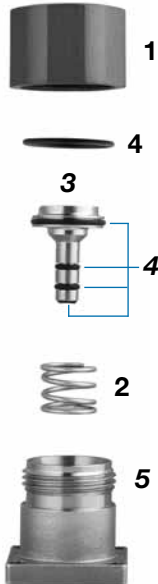

Materials of Construction

Component	Grade/ASTM Specification
1 Cap	Aluminum with black anodize (normally closed); aluminum with green anodize (normally open)
2 Spring	S17700 SS (normally closed); 302 SS (normally open)
3 Stem	316 SS/A276 or A479
4 O-rings	Fluorocarbon FKM
5 Body	CF3M/A351
Lubricant	PTFE-based

Wetted components listed in *italics*.

Ordering Information

Actuation Mode	2-Port Valve	3-Port Valve
Normally closed	SS-MPC-T2A-2-C	SS-MPC-T2A-3-C
Normally open	SS-MPC-T2A-2-O	SS-MPC-T2A-3-O

Kalrez Seal Option

Kalrez material is available in place of *wetted* fluorocarbon FKM O-ring material. To order, add **-KZ** to the ordering number.

Example: SS-MPC-T2A-2-C-**KZ**

Visual Indicator Option

The visual indicator provides visual indication of a *normally closed* valve's open position with a pop-up button. To order, add **-PI** to the ordering number.

Example: SS-MPC-T2A-2-C-**PI**

Indicator Switch Option

The indicator switch transmits a signal to an electrical device, indicating the open or closed position of a *normally closed* valve.

- Features a single-pole, single-throw switch rated at:

- 1/2 A for 115 V (ac) for a normally open switch;
- 1/4 A for 115 V (ac) for a normally closed switch;
- -40 to 185°F (-40 to 85°C) temperature.

- 24 in. (61 cm) wire lead with inline clip.

To order, add **M** for a normally open switch or **M-2** for a normally closed switch to the valve ordering number.

Example: SS-MPC-T2A-2-**CM**

Electronic Position Sensor Option

An electronic position sensor is available; see page 24. It cannot be ordered with the visual indicator or indicator switch options.

Multiple Options

Add designators in *alphabetical* order. Example: SS-MPC-T2A-2-C-**KZ-PI**

Visual Indicator



Indicator Switch



Swagelok Surface-Mount Components

Pneumatically Actuated Switching Valves, PSV Series

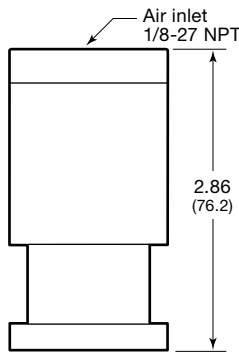

Features

- Flow coefficient: 0.06
- Wetted components: CF3M body; 316 SS stem and bonnet cylinder; fluorocarbon FKM seals
- Optional visual indicator

Pressure-Temperature Ratings

Working Pressure psig (bar)	Temperature °F (°C)	Actuator Pressure psig (bar)
300 (20.6)	0 to 300 (-17 to 148)	40 to 100 (2.8 to 6.8)

Materials of Construction

Component	Grade/ASTM Specification
1 Cap	Aluminum
2 Spring	S17700
3 Piston	Aluminum
4 Bonnet cylinder	316 SS/A276
5 O-rings	Fluorocarbon FKM
6 Stem	316 SS/A276
7 Body	CF3M/A351
Lubricant	PTFE-based

Wetted components listed in *italics*.

Ordering Information

Common Port	Ordering Number
Center	SS-MPC-PSV-3-CC
Side	SS-MPC-PSV-3-SC

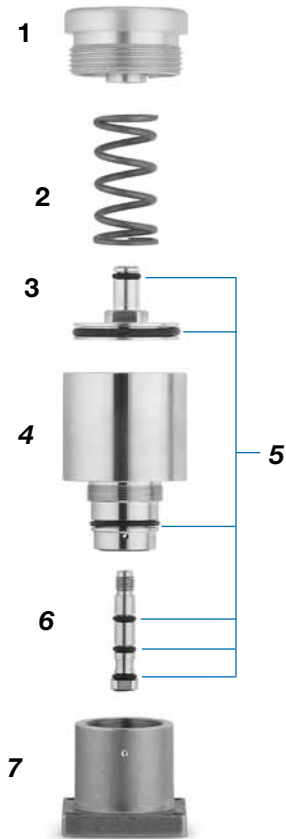

Switching Valve Flow Paths

Common Center Port

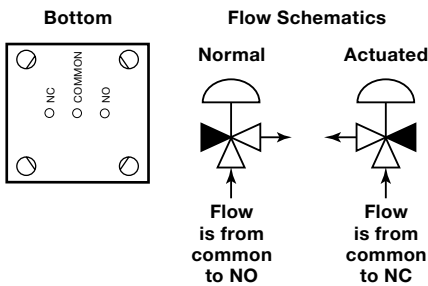

Common Side Port

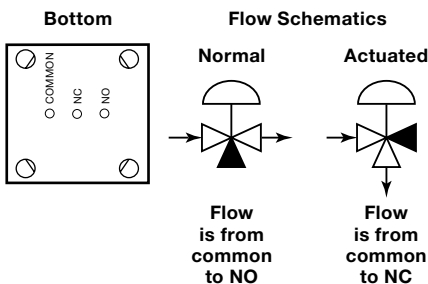

Kalrez Seal Option

Kalrez material is available in place of *wetted* fluorocarbon FKM O-ring material. To order, add **-KZ** to the ordering number.

Example: SS-MPC-PSV-3-CC-KZ

Visual Indicator Option

The visual indicator provides a visual indication of the *open* position of the valve with a pop-up button. To order, add **-PI** to the ordering number.

Example: SS-MPC-PSV-3-CC-PI



Multiple Options

Add designators in *alphabetical* order.
Example: SS-MPC-PSV-3-CC-KZ-P

Swagelok Surface-Mount Components

Proportional Relief Valves, R Series

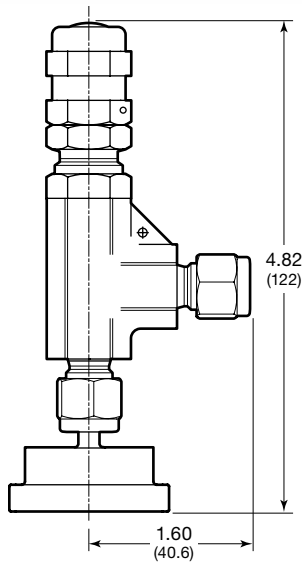

Features

- Valves OPEN when system pressure reaches the set pressure and CLOSE when system pressure falls below the set pressure.
- Wetted components:
 - 316 SS bonnet, body, stem, seat, insert, and retainers
 - fluorocarbon FKM and PTFE-coated fluorocarbon FKM and 316 SS seals
 - molybdenum disulfide-based dry film and paste and silicone-based lubricants

Low-Pressure Valves (RL3 Series)

- Pressure rating: 300 psig (20.6 bar)
- Temperature rating: 10 to 275°F (-12 to 135°C)
- One spring for the full set pressure range (10 to 225 psig [0.68 to 15.5 bar])

High-Pressure Valves (R3A Series)

Pressure-Temperature Ratings

Seal Material	Fluorocarbon FKM	Neoprene
Temperature °F (°C)	Working Pressure psig (bar)	
0 (-17)	—	3600 (248)
25 (-4)	3600 (248)	3600 (248)
100 (37)	3600 (248)	3600 (248)
150 (65)	3320 (228)	3320 (228)
200 (93)	3040 (209)	3040 (209)
250 (121)	2786 (191)	2786 (191)
300 (148)	—	2115 (145)

- Multiple springs for a selection of set pressure ranges

Applications

R series relief valves are proportional relief valves that open gradually as the pressure increases. Consequently, they do not have a capacity rating at a given pressure rise (accumulation), and they are not certified to ASME or any other codes.

- ⚠ **Some system applications require relief valves to meet specific safety codes. The system designer and user must determine when such codes apply and whether these relief valves conform to them.**
- ⚠ **Swagelok proportional relief valves should never be used as ASME Boiler and Pressure Vessel Code safety relief devices.**
- ⚠ **Swagelok proportional relief valves are not “Safety Accessories” as defined in the Pressure Equipment Directive 97/23/EC.**
- ⚠ **For valves not actuated for a period of time, initial relief pressure may be higher than the set pressure.**

For additional information, see the Swagelok *Proportional Relief Valves—R Series* catalog, MS-01-141.

Ordering Information

Low-Pressure Valves (RL3 Series)

Valve contains spring; set pressure must be adjusted. Select a valve ordering number and corresponding adapter ordering number.

End Connections		Ordering Number	Orifice in. (mm)	Adapter Ordering Number
Inlet/Outlet	Size			
Swagelok tube fittings	1/4 in.	SS-RL3S4	0.19 (4.8)	SS-MPC-DM-2-T4
	6 mm	SS-RL3S6MM		SS-MPC-DM-2-T6MM

High-Pressure Valves (R3A Series)

Valve does not contain spring. Select a valve ordering number, corresponding adapter ordering number, and spring kit ordering number.

End Connections		Ordering Number	Orifice in. (mm)	Adapter Ordering Number
Inlet/Outlet	Size			
Swagelok tube fittings	1/4 in.	SS-4R3A	0.14 (3.6)	SS-MPC-DM-2-T4
	6 mm	SS-6R3A-MM		SS-MPC-DM-2-T6MM

R3A series spring kits include a spring, label, 302 SS lock wire with seal, spring support, and installation instructions.

Add the spring designator for the desired set pressure range to basic kit ordering number **177-R3A-K1-**.

Example: 177-R3A-K1-A

Set Pressure Range psig (bar)	Spring Designator	Spring Color
50 to 350 (3.4 to 24.1)	A	Blue
350 to 750 (24.1 to 51.7)	B	Yellow
750 to 1500 (51.7 to 103)	C	Purple

Kalrez Seal Option

Kalrez material is available in place of *wetted* fluorocarbon FKM seal material for R3A series valves. To order, add **-KZ** to the ordering number.

Example: SS-4R3A-KZ

Swagelok Surface-Mount Components

Springless Diaphragm Valves, DP Series

Pneumatically Actuated Low-Pressure Valves

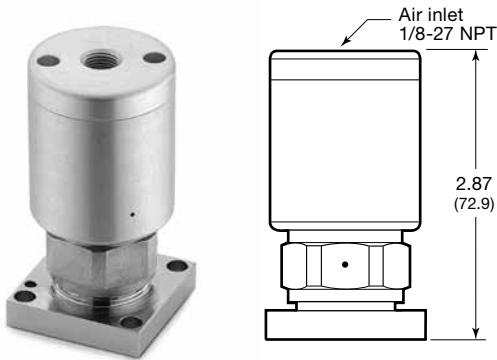

Features

- Pressure rating: 250 psig (17.2 bar)
- Temperature rating: 0 to 150°F (-17 to 65°C)
- Flow coefficient: 0.10
- Wetted components: 316L SS body; cobalt-based superalloy (UNS R30003) diaphragms; PCTFE seat
- Normally closed and normally open pneumatic actuators (normally open actuators are marked with a green ring on top of the cylinder)

Ordering Information

Actuation Mode	2-Port Valve	3-Port Valve
Normally closed	SS-MPC-DP-2-C	SS-MPC-DP-3-C
Normally open	SS-MPC-DP-2-O	SS-MPC-DP-3-O

Electronic Position Sensor Option

An electronic position sensor is available; see page 24.

Manual High-Pressure Valves

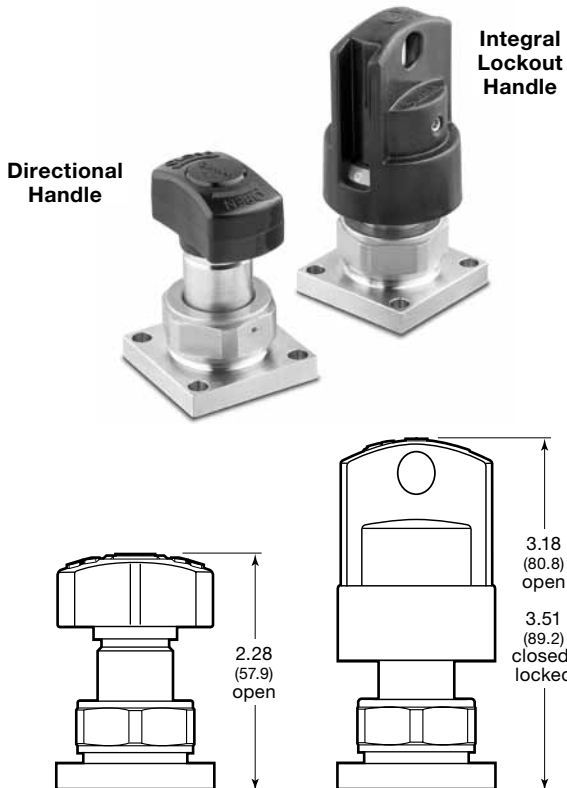

Features

- Pressure rating: 3045 psig (210 bar)
- Temperature rating: 0 to 150°F (-17 to 65°C)
- Flow coefficient: 0.10
- Wetted components: 316L SS body; cobalt-based superalloy (UNS R30003) diaphragms; PCTFE seat
- Directional handle—quarter-turn actuation with visual indication of open and closed position
- Integral lockout handle—quarter-turn actuation with lockout safety feature to prevent actuation (can be locked in the closed position only)

Ordering Information

Handle	2-Port Valve	3-Port Valve
Directional	SS-MPC-DPH-2	SS-MPC-DPH-3
Integral lockout	SS-MPC-DPHL-2	SS-MPC-DPHL-3

Handle Color Options

Standard handle color is black. To order an optional color, add a color designator to the ordering number.

Example:
SS-MPC-DPHL-2-RD

Handle Color	Designator
Blue	-BL
Green	-GR
Orange	-OG
Red	-RD
White	-WH
Yellow	-YW

For additional information, see the Swagelok *Springless Diaphragm Valves for High Performance—DP Series* catalog, MS-01-165.

Swagelok Surface-Mount Components

Stream Selector Valves, SSV Series



Cutaway, 1 SSV Module, Access Ports Not Shown

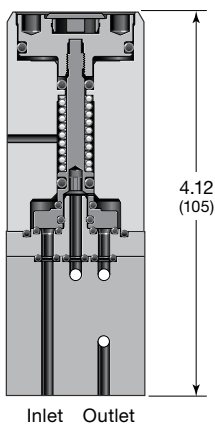

Bottom, 3 SSV Modules Shown

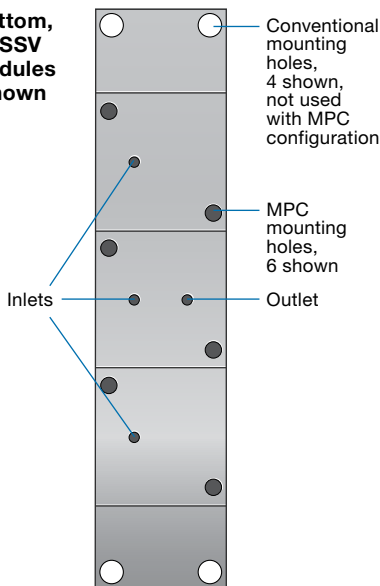

For additional information, see the Swagelok Stream Selector System for Process Analyzer Applications—SSV Series catalog, MS-02-326.

Features

- Pressure rating: 250 psig (17.2 bar)
- Temperature rating: 20 to 300°F (–6 to 148°C)
- Flow coefficient: 0.20 in all streams
- Wetted components: CF3M body; 316 SS flange and insert; fluorocarbon FKM seals; PTFE-based lubricant
- Double block-and-bleed functionality in each module
- Distinctive vented air gap prevents mixing of pneumatic actuator supply and system fluid
- Compact design saves cabinet space and reduces internal volume
- Actuation pressure range: 40 to 150 psig (2.8 to 10.3 bar)
- Atmospheric reference vent option ensures a constant sample pressure in repetitive analyses.
- High-purge flow loop option provides increased purgeability and cleanliness for applications requiring a high degree of sample purity.

Ordering Information and Dimensions

Number of Streams	Ordering Numbers		
	Standard SSV	Atmospheric Reference Vent Option	High-Purge SSV Option
2	SS-SSV-V-2-MPC	SS-SSV-V-2-MPC-ARV	SS-SSVP-V-2-MPC
3	SS-SSV-V-3-MPC	SS-SSV-V-3-MPC-ARV	SS-SSVP-V-3-MPC
4	SS-SSV-V-4-MPC	SS-SSV-V-4-MPC-ARV	SS-SSVP-V-4-MPC
5	SS-SSV-V-5-MPC	SS-SSV-V-5-MPC-ARV	SS-SSVP-V-5-MPC
6	SS-SSV-V-6-MPC	SS-SSV-V-6-MPC-ARV	SS-SSVP-V-6-MPC
7	SS-SSV-V-7-MPC	SS-SSV-V-7-MPC-ARV	SS-SSVP-V-7-MPC
8	SS-SSV-V-8-MPC	SS-SSV-V-8-MPC-ARV	SS-SSVP-V-8-MPC
9	SS-SSV-V-9-MPC	SS-SSV-V-9-MPC-ARV	SS-SSVP-V-9-MPC
10	SS-SSV-V-10-MPC	SS-SSV-V-10-MPC-ARV	SS-SSVP-V-10-MPC

Vented Air Gap Threaded Test Port Option

A 1/8 in. female NPT threaded test port is available for the vented air gap. To order a Swagelok SSV system with threaded test ports, insert **T** into the valve ordering number as shown.

Example: SS-SSV-VT-2-MPC

Kalrez Seal Option

Kalrez seals are available in place of the *wetted* fluorocarbon FKM seals. For pressure-temperature ratings, see table at right. To order, replace **V** in the valve ordering number with **K**.

Example: SS-SSV-K-2-MPC

Simriz® Seal Option

Simriz seals are available in place of the *wetted* fluorocarbon FKM seals. For pressure-temperature ratings, see table at right. To order, replace **V** in the valve ordering number with **Z**.

Example: SS-SSV-Z-2-MPC

Electronic Position Sensor Option

An electronic position sensor is available; see page 24.

Temperature °F (°C)	Working Pressure psig (bar)
Kalrez Seals	
30 (–1)	100 (6.8)
40 (4)	250 (17.2)
70 (20)	250 (17.2)
300 (148)	250 (17.2)
Simriz Seals	
30 (–1)	200 (13.7)
40 (4)	250 (17.2)
70 (20)	250 (17.2)
250 (121)	250 (17.2)

Swagelok Surface-Mount Components

Pressure Gauges, M Model

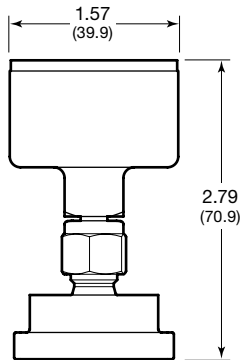

Features

- 40 mm (1 1/2 in.) dial size
- Miniature size allows placement in compact spaces.
- Snap-in lens saves space compared to twist-on lens.

Materials of Construction

Component	Material
<i>End connection</i>	316 SS
<i>Bourdon tube</i>	
Case	304 SS
Movement	Stainless steel
Lens	Acrylic
Dial	Aluminum
Pointer	

Wetted components listed in *italics*.

Technical Data

Ranges

- Compound gauges
 - Vacuum to 15 psi through vacuum to 60 psi
 - Vacuum to 0.6 bar through vacuum to 3 bar
- Positive-pressure gauges
 - 0 to 15 psi through 0 to 5000 psi
 - 0 to 1 bar through 0 to 250 bar

Accuracy

- ±2.5 % of span (ASME B40.1 Grade C, EN 837-1 Class 2.5, JIS B7505 Class 2.5)

Configuration

- Center-back mount

End Connections

- 1/4 in. Swagelok tube adapter
- 6 mm Swagelok tube adapter

Operating Temperature

- Ambient
-40 to 140°F (-40 to 60°C)
- Media
212°F (100°C) maximum

Temperature Error

- ±0.4 % for every 18°F (10°C) temperature change from 68°F (20°C)

Ordering Information

The selected dial range should be approximately two times the system working pressure, and the system working pressure should be in the middle half (25 to 75 %) of the dial range. Contact your authorized Swagelok representative if the system working pressure will exceed 75 % of the dial range.

Dial Range in psi, 1/4 in. Swagelok Tube Adapter End Connection

Insert a dial range designator from the table below into basic ordering number **PGI-40M-____-CAQX**

Example: PGI-40M-PC15-CAQX

Dial Range, psi (primary scale: psi; secondary scale: bar)		
Minimum	Maximum	Designator
Vacuum -0.30 in. Hg	15	PC15
	30	PC30
	60	PC60
0	15	PG15
	30	PG30
	60	PG60
	100	PG100
	200	PG200
	300	PG300
	400	PG400
	1000	PG1000
	2000	PG2000
5000	PG5000	

A surface-mount adapter is required.

Ordering number: **SS-MPC-DM-2-S4**

Dial Range in bar, 6 mm Swagelok Tube Adapter End Connection

Insert a dial range designator from the tables below into basic ordering number **PGI-40M-____-CASX**

Example: PGI-40M-BC.6-CASX

Dial Range, bar (primary scale: bar; secondary scale: psi)		
Minimum	Maximum	Designator
Vacuum -1 bar	0.6	BC.6
	1.5	BC1.5
	3	BC3
0	1	BG1
	2.5	BG2.5
	4	BG4
	10	BG10
	16	BG16
	25	BG25
	60	BG60
	100	BG100
	250	BG250

A surface-mount adapter is required.

Ordering number: **SS-MPC-DM-2-S6MM**

See **Surface-Mount Adapters**, page 23, for more information.

For additional information, see the Swagelok *Pressure Gauges, Industrial and Process—PGI Series* catalog, MS-02-170.

Swagelok Surface-Mount Components

Digital Pressure and Temperature Transducers, PTX Series

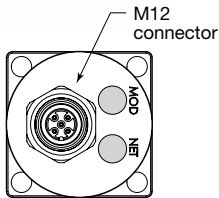

Top

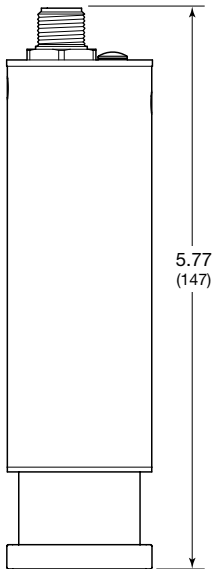

Front

Features

- MEMS pressure-sensing technology, fast response, excellent long-term stability
- Network connectivity allows for one cable both to power the unit and to send pressure and temperature feedback in near real time
- One-piece machined stainless steel diaphragm
- Innovative flow path with no dead legs
- UL certified for use in hazardous areas
- Measures temperature from 23 to 158°F (-5 to 70°C)

Materials of Construction

Component	Material Grade/ ASTM Specification
1 Top cap	300 series SS
2 Housing O-ring	Fluorocarbon FKM
3 Housing	316 SS/A479
4 <i>Diaphragm with MEMS sensing element</i>	316 SS/A479
5 <i>Sensor O-ring</i>	Kalrez 6375
6 <i>Body</i>	316 SS/A479

Wetted components listed in *italics*.

Ordering Information

Build a PTX series transducer ordering number by adding the designators in the sequence shown below.

A B
 SS - PTX - D - **G050** - SM - K

A Full-Scale Range

- G050** = 0 to 50 psig (3.4 bar)
- G250** = 0 to 250 psig (17.2 bar)
- G500** = 0 to 500 psig (34.4 bar)

B End Connections

SM = 1.5 in. Swagelok MPC modular surface mount in accordance with ANSI/ISA 76.00.02

For additional information, see the Swagelok *Digital Pressure and Temperature Transducers* catalog, MS-02-434.

Swagelok Surface-Mount Components

Variable Area Flowmeters, G2 Model

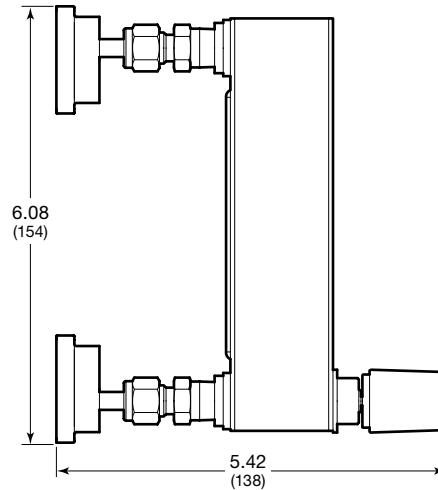

For additional information, see the Swagelok *Variable Area Flowmeters—G Series and M Series* catalog, MS-02-346.

Features

- Maximum inlet pressure: 145 psig (10 bar) at 70°F (20°C)
- Temperature ranges
 - Process: 23 to 212°F (–5 to 100°C); 149°F (65°C) max with limit switches
 - Ambient: –4 to 212°F (–20 to 100°C); 149°F (65°C) max with limit switches
- Accuracy class: 2.5
- Wetted components: 316L SS head piece, foot piece, and needle; 316Ti SS needle valve housing and spring; 316 SS float; borosilicate glass measuring tube; PFA, PTFE, fluorocarbon FKM, perfluorocarbon FFKM, or EDPM float stops, gaskets, and O-rings
- Polycarbonate cover for protection
- Integral fine-metering needle valve
- Optional limit switches

Ordering Information

Build a G2 model variable area flowmeter ordering number by combining the designators in the sequence shown below. Standard flow ranges in other units of measure and custom calibrated flowmeters are available. See the Swagelok *Variable Area Flowmeters—G Series and M Series* catalog, MS-02-346.

4
 5
 6
 7
VAF - G2 - 01L - 1 - 1 - A

4 Measured Flow Range

Air, NL/min	Water, L/min
01L = 0.011 to 0.11	A1L = 0.004 to 0.04
02L = 0.013 to 0.13	A2L = 0.008 to 0.08
03L = 0.027 to 0.27	A3L = 0.02 to 0.2
04L = 0.07 to 0.7	A4L = 0.04 to 0.4
05L = 0.1 to 1.0	A5L = 0.065 to 0.65
06L = 0.17 to 1.7	A6L = 0.1 to 1.0
07L = 0.42 to 4.2	A7L = 0.17 to 1.7
08L = 0.83 to 8.3	A8L = 0.2 to 2.0
09L = 1.3 to 13	A9L = 0.28 to 2.8
10L = 1.7 to 17	
11L = 3.0 to 30	
12L = 4.0 to 40	
13L = 5.0 to 50	
14L = 6.8 to 68	
15L = 8.4 to 84	

5 Flowmeter Gasket, Valve O-Ring Material

- 1 = Fluorocarbon (FKM) (standard)
- 2 = Perfluorocarbon (FFKM)
- 3 = EPDM

6 Limit Switches

Most G2 model flowmeters can accept up to two limit switches; see footnote below.

Limit switch amplifiers are required. Amplifiers can be ordered with the flowmeter or customer supplied.

- 0 = None
- 1 = One switch
- 2 = Two switches^①
- 3 = One switch and a one-channel isolated switch amplifier with relay output, 115 V (ac)
- 4 = Two switches and a two-channel isolated switch amplifier with relay output, 115 V (ac)^①
- 5 = One switch and a one-channel isolated switch amplifier with relay output, 230 V (ac)
- 6 = Two switches and a two-channel isolated switch amplifier with relay output, 230 V (ac)^①

^① Not available with measured air flow ranges 13L, 14L, and 15L or with measured water flow ranges A7L, A8L, and A9L.

7 Options

Add multiple designators in alphabetical order; omit final dash (-) if no options are ordered. See the Swagelok *Variable Area Flowmeters—G Series and M Series* catalog, MS-02-346, for more information about options.

- A** = Limit switch junction box
- G** = 5-point calibration record
- H** = Pressure test, certificate
- J** = Material certification
- X* = Oil- and grease-free cleaning, test report (required for oxygen service)
- Y** = No needle valve
- Z** = Top-mounted needle valve

Two surface-mount adapter sets are required. Ordering numbers:

- **SS-MPC-DM-1-T4-OFFSET-165** and **SS-400-1-4** for 1/4 in. connections
- **SS-MPC-DM-1-T6MMOFFSET165** and **SS-6M0-1-4** for 6 mm connections.

Swagelok Surface-Mount Components

Pressure-Reducing Regulators, KCP Series



Features

- Maximum inlet pressure: 3600 psig (248 bar)
- Pressure control ranges: 0 to 10 psig (0 to 0.68 bar) through 0 to 1500 psig (0 to 103 bar)
- Maximum operating temperature: 176°F (80°C)
- Flow coefficients: 0.02 and 0.06
- Wetted components:
 - 316 SS body, seat retainer, piston
 - S17400 SS poppet
 - 302 SS poppet spring
 - PCTFE seat
 - fluorocarbon FKM or Kalrez seals
 - PTFE-based lubricant

For additional information, see the Swagelok *Pressure Regulators* catalog, MS-02-230.

Ordering Information

Build a KCP series pressure regulator ordering number by combining the designators in the sequence shown below.

4 5 6 7 8 9 10 11 12 13 14 15 16
KCP 1 C F 5 M A 2 P 1 0 0 0 0

4 Body Material
1 = 316 SS

5 Pressure Control Range
C = 0 to 10 psig (0 to 0.68 bar)
D = 0 to 25 psig (0 to 1.7 bar)
E = 0 to 50 psig (0 to 3.4 bar)
F = 0 to 100 psig (0 to 6.8 bar)
G = 0 to 250 psig (0 to 17.2 bar)
J = 0 to 500 psig (0 to 34.4 bar)
L = 0 to 1000 psig (0 to 68.9 bar)
M = 0 to 1500 psig (0 to 103 bar)

6 Maximum Inlet Pressure^①
F = 100 psig (6.8 bar)
J = 500 psig (34.4 bar)
L = 1000 psig (68.9 bar)
R = 3600 psig (248 bar)

^① For better resolution and control, select a pressure that closely matches system pressure.

7 Port Configuration
5, 6

See *Port Configurations*, right.

8 Ports
M = MPC platform

9 Seat, Seal Material
A = PCTFE, fluorocarbon FKM
B = PCTFE, Kalrez

10 Flow Coefficient (C_v)
1 = 0.02
2 = 0.06

11 Sensing Mechanism
P = 316 SS piston

12 Handle
1 = Thumbwheel

13 Isolation Valves
0 = No valves

14 Cylinder Connections
0 = No connections

15 Gauges
0 = No gauges

16 Options
0 = No options

Port Configurations

2-Port Regulator	Designator	3-Port Regulator	Designator
	5		6

Swagelok Surface-Mount Components

Back-Pressure Regulators, KCB Series



Features

- Maximum inlet pressure: equal to pressure control range
- Pressure control ranges: 0 to 10 psig (0 to 0.68 bar) through 0 to 250 psig (17.2 bar)
- Maximum operating temperature: 176°F (80°C)
- Flow coefficient: 0.10
- Wetted components:
 - 316 SS body, seat retainer, piston
 - fluorocarbon FKM or Kalrez seat and piston seal
 - PCTFE retainer seal
 - PTFE-based lubricant

For additional information, see the Swagelok *Pressure Regulators* catalog, MS-02-230.

Ordering Information

Build a KCB series back-pressure regulator ordering number by combining the designators in the sequence shown below.

4 5 6 7 8 9 10 11 12 13 14 15 16
 KCB 1 F 0 7 M A 4 P 1 0 0 0 0

4 Body Material

1 = 316 SS

5 Pressure Control Range

- C = 0 to 10 psig (0 to 0.68 bar)
- D = 0 to 25 psig (0 to 1.7 bar)
- E = 0 to 50 psig (0 to 3.4 bar)
- F = 0 to 100 psig (0 to 6.8 bar)
- G = 0 to 250 psig (0 to 17.2 bar)

6 Maximum Inlet Pressure^①

0 = Not applicable (equal to pressure control range)

7 Port Configuration

7, 8

See *Port Configurations, right*.

8 Ports

M = MPC platform

9 Seat, Seal Material

- A = Fluorocarbon FKM, PCTFE
- B = Kalrez, PCTFE

10 Flow Coefficient (C_v)

4 = 0.10

11 Sensing Mechanism

P = 316 SS piston

12 Handle

1 = Thumbwheel

13 Valves

0 = No valves

14 Cylinder Connections

0 = No connections

15 Gauges

0 = No gauges

16 Options

0 = No options

Port Configurations

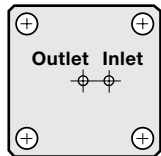
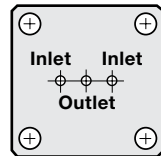
2-Port Regulator	Designator	3-Port Regulator	Designator
	7		8

Swagelok Surface-Mount Components

Tee-Type Filters, TF Series

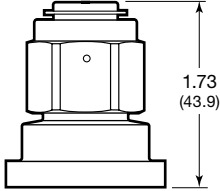

For additional information, see the Swagelok Filters—FW, F, and TF Series catalog, MS-01-92.

Features

Pressure-Temperature Ratings

Seal Material	Fluorocarbon FKM
Temperature °F (°C)	Working Pressure psig (bar)
0 (-17) to 100 (37)	3600 (248)
150 (65)	3320 (228)
200 (93)	3040 (209)
250 (121)	2786 (191)
300 (148)	2115 (145)

- Wetted components: 316L SS body; 316 SS bonnet, elements, and gasket (silver plated); 302 SS spring
- Replaceable elements in a variety of nominal pore sizes

Flow Data at 70°F (20°C)

Element Nominal Pore Size µm	Inlet Pressure, ^① psig (bar)			Pressure Drop, psi (bar)		
	5 (0.34)	10 (0.68)	15 (1.0)	10 (0.68)	50 (3.4)	100 (6.8)
	Air Flow, std ft ³ /min (std L/min)			Water Flow, U.S. gal/min (L/min)		
0.5	0.13 (3.6)	0.20 (5.6)	0.26 (7.3)	0.04 (0.15)	0.10 (0.37)	0.14 (0.52)
2	0.39 (11)	0.59 (16)	0.77 (21)	0.13 (0.49)	0.30 (1.1)	0.42 (1.5)
7	0.55 (15)	0.83 (23)	1.1 (31)	0.19 (0.71)	0.42 (1.5)	0.59 (2.2)
15	0.61 (17)	0.93 (26)	1.2 (33)	0.21 (0.79)	0.47 (1.7)	0.66 (2.4)
60	0.76 (21)	1.2 (33)	1.5 (42)	0.26 (0.98)	0.58 (2.1)	0.82 (3.1)
90	0.82 (23)	1.2 (33)	1.6 (45)	0.28 (1.0)	0.62 (2.3)	0.88 (3.3)
40, 140, 230, 440						

^① Outlet is discharged to atmosphere.

Ordering Information

Element Nominal Pore Size µm	2-Port Filter	3-Port Filter
Sintered Elements		
0.5	SS-MPC-4TF-2-05	SS-MPC-4TF-3-05
2	SS-MPC-4TF-2-2	SS-MPC-4TF-3-2
7	SS-MPC-4TF-2-7	SS-MPC-4TF-3-7
15	SS-MPC-4TF-2-15	SS-MPC-4TF-3-15
60	SS-MPC-4TF-2-60	SS-MPC-4TF-3-60
90	SS-MPC-4TF-2-90	SS-MPC-4TF-3-90
Strainer Elements		
40	SS-MPC-4TF-2-40	SS-MPC-4TF-3-40
140	SS-MPC-4TF-2-140	SS-MPC-4TF-3-140
230	SS-MPC-4TF-2-230	SS-MPC-4TF-3-230
440	SS-MPC-4TF-2-440	SS-MPC-4TF-3-440

Swagelok Surface-Mount Components

Surface-Mount Adapters



Swagelok Tube Fitting

Tube Stub

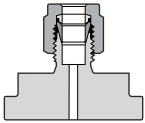

1-Port

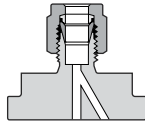

2-Port

Features

- Material: CF3M
- Surface-mount component designed with a vertical port on the top of the adapter and a choice of one or two ports to the substrate layer below
- Vertical ports available with Swagelok tube fitting, female NPT, or tube stub connections

Ordering Information

Vertical Port		1-Port Adapter	2-Port Adapter	Height ^① in. (mm)
Type	Size			
Swagelok tube fitting	1/8 in.	SS-MPC-DM-1-S2	SS-MPC-DM-2-S2	1.20 (30.5)
	1/4 in.	SS-MPC-DM-1-S4	SS-MPC-DM-2-S4	1.30 (33.0)
	3 mm	SS-MPC-DM-1-S3MM	SS-MPC-DM-2-S3MM	1.20 (30.5)
	6 mm	SS-MPC-DM-1-S6MM	SS-MPC-DM-2-S6MM	1.30 (33.0)
Female NPT	1/8 in.	SS-MPC-DM-1-F2	SS-MPC-DM-2-F2	0.78 (19.8)
	1/4 in.	SS-MPC-DM-1-F4	SS-MPC-DM-2-F4	
Tube stub	1/4 × 0.035 in.	SS-MPC-DM-1-T4	SS-MPC-DM-2-T4	1.50 (38.2)
	6 × 1.0 mm	SS-MPC-DM-1-T6MM	SS-MPC-DM-2-T6MM	

① Dimensions shown with Swagelok tube fitting nuts finger-tight.

Substrate Caps



Zero-Port

2-Port



Features

- Material: CF3M
- Surface-mount component designed to cover an unused position on the substrate layer
- Choice of a zero-port cap to block flow across the surface-mount position, or a two-port cap to provide a flow path across the surface-mount position

Ordering Information

Zero-Port Cap	2-Port Cap
SS-MPC-DM-0-CAP	SS-MPC-DM-2-CAP

Surface-Mount Accessories

Electronic Position Sensors

Select surface-mount valves are available with electronic position sensors, which transmit a signal to an electrical device indicating:

- the *open* position of:
 - pneumatically actuated DP series low-pressure valves, normally open and normally closed
 - PSV series switching valves
 - T2A series shutoff valves, normally open and normally closed.
- the *closed* position of SSV series stream selector valves.

Features

Standard industrial and intrinsically safe sensor models are available. Both models:

- offer instant, remote confirmation of valve actuator position
- validate valve response.

The industrial model aids troubleshooting with a local LED indicator.

The intrinsically safe model is designed for use in applications where intrinsically safe or nonincendive ratings are required, such as hazardous environments or media.



Surface-mount valves with standard industrial electronic position sensors: normally closed DP series valve, left, and normally closed T2A series valve.

Standard Industrial Sensor

Electrical Specifications

Turck Part Number	Bi 1-EG05-AP6X
Connection	Turck picofast® snap lock, 3-pin (PKG 3Z cable)
Output	3-wire V (dc)—transistor (PNP current-sourcing)
Voltage	10 to 30 V (dc) polarity protected—pulsed SCP
Output Function	Normally open
Operating Temperature	-23 to 70°C (-10 to 158°F)

Intrinsically Safe Sensor

Electrical Specifications

Turck Part Number	Bi 1-EG05-Y1
Connection	Turck picofast snap lock, 3-pin (PKG 3Z cable)
Output	2-wire NAMUR-style (IEC60947-5-6 [EN60947-5-6])
Voltage	NAMUR switch amplifier required
Output Function	Normally open
Operating Temperature	-23 to 70°C (-10 to 158°F)

Ordering Information

To order an electronic position sensor factory assembled, add:

- **-PS** for a standard industrial sensor
 - **-PS-IS** for an intrinsically safe sensor
- to a pneumatically actuated DP series, PSV series, T2A series, or SSV series surface-mount component ordering number.

Examples: SS-MPC-DP-2-C-PS
SS-MPC-PSV-3-SC-PS-IS

Wiring Diagram

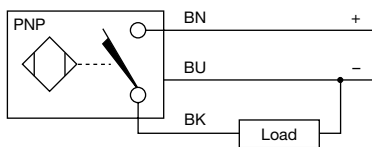

Wiring Diagram

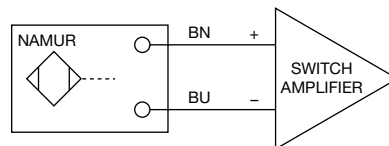

Surface-Mount Accessories

Digital Valve Control Modules (VCM)

The Swagelok VCM uses a sophisticated control and monitoring system to operate up to six pneumatic stream selecting valves or other discrete valves. This compact system reduces complicated cabling and minimizes overall power consumption.

Features

- 300 series stainless steel construction
- Network-controlled automatic valve actuation with DeviceNet™ network interface
- Indicator LEDs for pilot valve state, network status, and module status
- Threaded end connections for inlet, outlets, and exhaust; push-to-connect fittings available for 1/8 in. plastic tubing
- UL certified for use in hazardous areas
- Proximity sensor interface option to ensure proper valve actuation

Ordering Information

Select an ordering number.

Proximity Sensor Interface	Ordering Number
No interface	SS-VCM-D-6-0
Terminal strip with sealed enclosure	SS-VCM-D-6-2

The SS-VCM-D-6-2 model is designed to work with the MPC surface-mount components equipped with the Turck Bi 1-EG05-AP6X position sensor; see page 24.

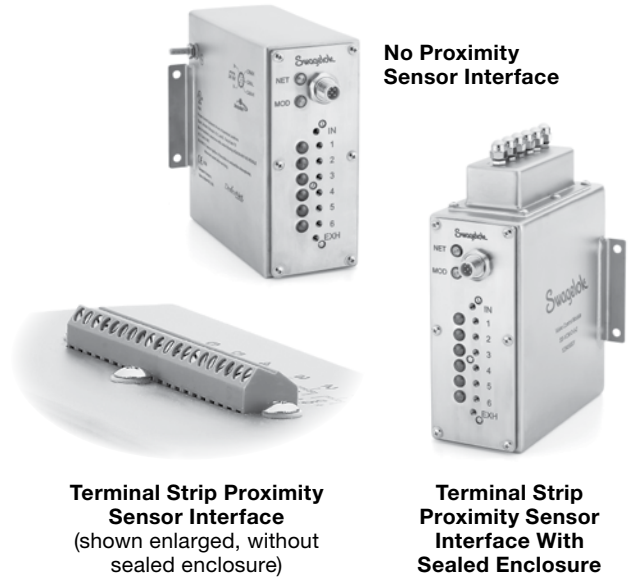

For more information, see the Swagelok *Digital Valve Control Module (VCM)* catalog, MS-02-435.

Swagelok Substrate and Manifold Components

Dimensions, in inches (millimeters), are for reference only and are subject to change.



Substrate Channels

Number of Surface-Mount Positions	Ordering Number	A in. (mm)	Number of Surface-Mount Positions	Ordering Number	A in. (mm)
1	A-MPC-SB-01	2.60 (66.0)	8	A-MPC-SB-08	13.3 (338)
2	A-MPC-SB-02	4.13 (105)	9	A-MPC-SB-09	14.8 (376)
3	A-MPC-SB-03	5.66 (144)	10	A-MPC-SB-10	16.4 (417)
4	A-MPC-SB-04	7.19 (183)	11	A-MPC-SB-11	17.9 (455)
5	A-MPC-SB-05	8.72 (221)	12	A-MPC-SB-12	19.4 (493)
6	A-MPC-SB-06	10.2 (259)	13	A-MPC-SB-13	21.0 (533)
7	A-MPC-SB-07	11.8 (300)	14	A-MPC-SB-14	22.5 (572)

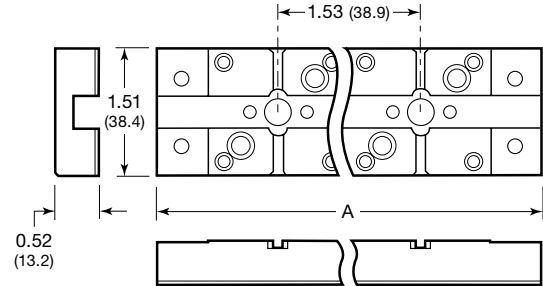

Substrate Flow Components

Surface-Mount Connectors

Cutaway	Description		Ordering Number	A in. (mm)
	Port 1	Port 2		
	Side	Side	6L-MPC-WS-SHSH	1.22 (31.0)
		Center	6L-MPC-WS-SHLG	1.53 (38.9)
		Center and manifold	6L-MPC-WS-SHDT	
		Manifold	6L-MPC-WS-SHDE	
	Center	Center	6L-MPC-WS-LGLG	1.83 (46.5)
		Center and manifold	6L-MPC-WS-LGDT	
		Manifold	6L-MPC-WS-LGDE	
	Center and manifold	Center and manifold	6L-MPC-WS-DTDT	
		Manifold	6L-MPC-WS-DTDE	
	Manifold	Manifold	6L-MPC-WS-DEDE	

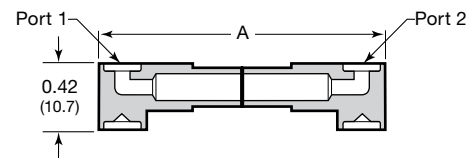

Swagelok Substrate and Manifold Components

Dimensions, in inches (millimeters), are for reference only and are subject to change.

Substrate Flow Components

Substrate End Connectors

Description		Ordering Number	Dimensions, in. (mm)		
Port 1	Port 2		A	B	D
1/8 in. Swagelok tube fitting	Side	6L-MPC-WS-SHS2	1.65 (41.9)	1.50 (38.1)	0.50 (12.7)
	Center	6L-MPC-WS-LGS2	1.96 (49.8)	1.81 (46.0)	
	Center and manifold	6L-MPC-WS-DTS2			
	Manifold	6L-MPC-WS-DES2			
1/4 in. Swagelok tube fitting	Side	6L-MPC-WS-SHS4	1.59 (40.4)	1.44 (36.6)	0.60 (15.2)
	Center	6L-MPC-WS-LGS4	1.90 (48.31)	1.75 (44.4)	
	Center and manifold	6L-MPC-WS-DTS4			
	Manifold	6L-MPC-WS-DES4			
3 mm Swagelok tube fitting	Side	6L-MPC-WS-SHS3MM	1.65 (41.9)	1.50 (38.1)	0.50 (12.7)
	Center	6L-MPC-WS-LGS3MM	1.96 (49.8)	1.81 (46.0)	
	Center and manifold	6L-MPC-WS-DTS3MM			
	Manifold	6L-MPC-WS-DES3MM			
6 mm Swagelok tube fitting	Side	6L-MPC-WS-SHS6MM	1.59 (40.4)	1.44 (36.6)	0.60 (15.2)
	Center	6L-MPC-WS-LGS6MM	1.90 (48.31)	1.75 (44.4)	
	Center and manifold	6L-MPC-WS-DTS6MM			
	Manifold	6L-MPC-WS-DES6MM			

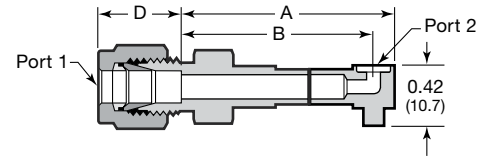

Side

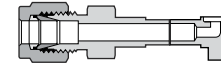

Center

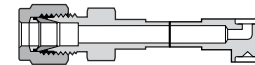

Center and Manifold

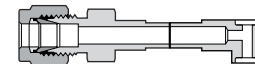

Manifold

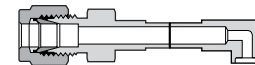

Dimensions shown with Swagelok tube fitting nuts finger-tight.

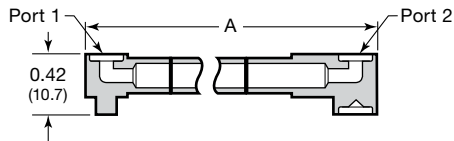

Jumper Tube Connectors

Number of Surface-Mount Positions Skipped	Ordering Number	A in. (mm)
1	6L-MPC-WS-SHTB01SH ^①	2.75 (69.8)
	6L-MPC-WS-SHTB01LG	3.06 (77.7)
2	6L-MPC-WS-SHTB02LG	4.59 (117)
3	6L-MPC-WS-SHTB03LG	6.12 (155)
4	6L-MPC-WS-SHTB04LG	7.65 (194)
5	6L-MPC-WS-SHTB05LG	9.18 (233)
6	6L-MPC-WS-SHTB06LG	10.7 (272)
7	6L-MPC-WS-SHTB07LG	12.2 (310)
8	6L-MPC-WS-SHTB08LG	13.8 (351)

^① Used with SSV stream selector valve outlet.

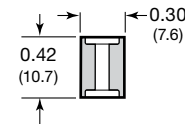

Drop-Down Connector and Plug

Cutaway	Description	Ordering Number
	Drop-down connector for substrate to manifold	6L-MPC-WS-DD
	Plug for manifold port with no substrate component above	6L-MPC-WS-DP

Swagelok Substrate and Manifold Components

Dimensions, in inches (millimeters), are for reference only and are subject to change.



Manifold Flow Components

Tee Connectors

Elbow-to-Elbow

Number of Surface-Mount Positions	Ordering Number	A in. (mm)
2	6L-MPC-MS-MEME	2.00 (50.8)
3	6L-MPC-MS-MEMT01ME	3.60 (91.4)
4	6L-MPC-MS-MEMT02ME	5.20 (132)
5	6L-MPC-MS-MEMT03ME	6.80 (173)
6	6L-MPC-MS-MEMT04ME	8.40 (213)
7	6L-MPC-MS-MEMT05ME	10.0 (254)
8	6L-MPC-MS-MEMT06ME	11.6 (295)
9	6L-MPC-MS-MEMT07ME	13.2 (335)
10	6L-MPC-MS-MEMT08ME	14.8 (376)

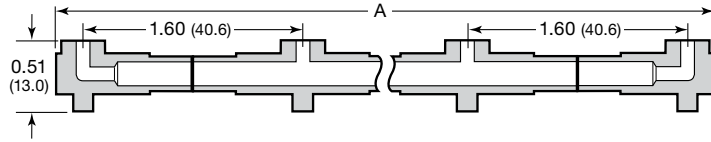

Elbow-to-Swagelok Tube Fitting

Number of Surface-Mount Positions	Basic Ordering Number	A in. (mm)
1	6L-MPC-MS-ME	1.58 (40.1)
2	6L-MPC-MS-MEMT01	3.18 (80.8)
3	6L-MPC-MS-MEMT02	4.78 (121)
4	6L-MPC-MS-MEMT03	6.38 (162)
5	6L-MPC-MS-MEMT04	7.98 (203)
6	6L-MPC-MS-MEMT05	9.60 (244)
7	6L-MPC-MS-MEMT06	11.2 (284)
8	6L-MPC-MS-MEMT07	12.8 (325)
9	6L-MPC-MS-MEMT08	14.4 (366)
10	6L-MPC-MS-MEMT09	16.0 (406)

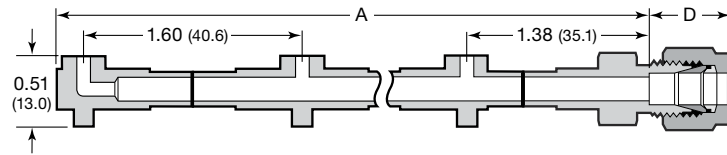

To order, add a Swagelok tube fitting size designator to a basic ordering number.

Example:
6L-MPC-MS-MES4

Swagelok Tube Fitting Size	Designator	D in. (mm)
1/8 in.	S2	0.50 (12.7)
1/4 in.	S4	0.60 (15.2)
3 mm	S3MM	0.50 (12.7)
6 mm	S6MM	0.60 (15.2)

Dimensions shown with Swagelok tube fitting nuts finger-tight.

Swagelok Tube Fitting-to-Swagelok Tube Fitting

Number of Surface-Mount Positions	Basic Ordering Number	A in. (mm)
1	6L-MPC-MS-___MT01	3.01 (76.5)
2	6L-MPC-MS-___MT02	4.61 (117)
3	6L-MPC-MS-___MT03	6.21 (158)
4	6L-MPC-MS-___MT04	7.81 (198)
5	6L-MPC-MS-___MT05	9.40 (239)
6	6L-MPC-MS-___MT06	11.0 (279)
7	6L-MPC-MS-___MT07	12.6 (320)
8	6L-MPC-MS-___MT08	14.2 (361)
9	6L-MPC-MS-___MT09	15.8 (401)
10	6L-MPC-MS-___MT10	17.4 (442)

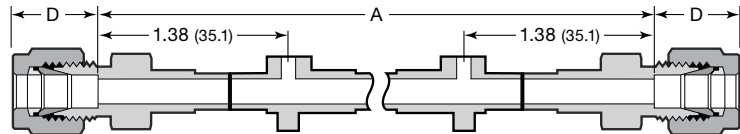

To order, insert a Swagelok tube fitting size designator as shown *and* add the same designator to a basic ordering number.

Example: 6L-MPC-MS-S4MT01S4

Swagelok Tube Fitting Size	Designator	D in. (mm)
1/8 in.	S2	0.50 (12.7)
1/4 in.	S4	0.60 (15.2)
3 mm	S3MM	0.50 (12.7)
6 mm	S6MM	0.60 (15.2)

Dimensions shown with Swagelok tube fitting nuts finger-tight.

Swagelok Substrate and Manifold Components

Dimensions, in inches (millimeters), are for reference only and are subject to change.



Manifold Channels

Number of Surface-Mount Positions	Ordering Number	A in. (mm)
1	A-MPC-MB-01	1.59 (40.4)
2	A-MPC-MB-02	3.19 (81.0)
3	A-MPC-MB-03	4.79 (122)
4	A-MPC-MB-04	6.39 (162)
5	A-MPC-MB-05	7.99 (203)
6	A-MPC-MB-06	9.59 (244)
7	A-MPC-MB-07	11.2 (284)
8	A-MPC-MB-08	12.8 (325)
9	A-MPC-MB-09	14.4 (366)
10	A-MPC-MB-10	16.0 (406)

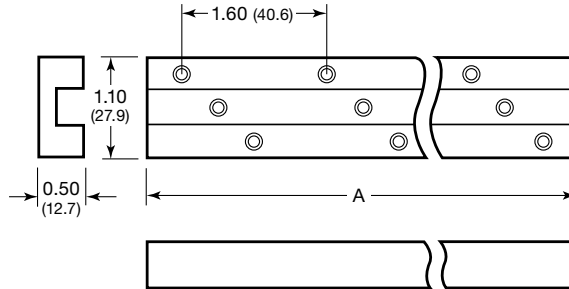

Parallel Manifold Channels

Number of Surface-Mount Positions	Ordering Number	A in. (mm)
3	A-MPC-PB-03	4.30 (109)
4	A-MPC-PB-04	5.83 (148)
5	A-MPC-PB-05	7.36 (187)
6	A-MPC-PB-06	8.89 (226)

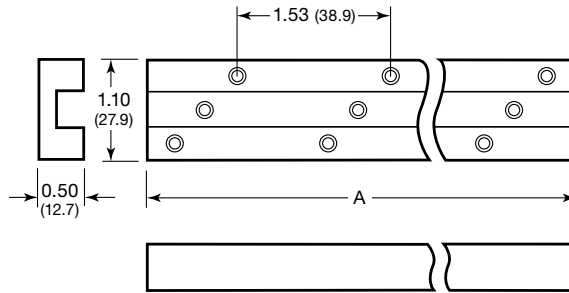

Parallel Manifold Components

Jumper Tube Connectors

Number of Surface-Mount Positions	Ordering Number	A in. (mm)
3	6L-MPC-MS-METB01ME	3.50 (88.9)
4	6L-MPC-MS-METB02ME	5.03 (128)
5	6L-MPC-MS-METB03ME	6.56 (167)
6	6L-MPC-MS-METB04ME	8.09 (205)

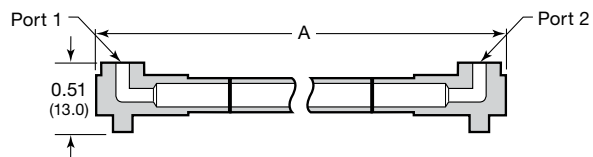

Seals, Mounting Blocks, and Assembly Hardware

Seals

Item	Description	Ordering Number	Function	Material
	O-ring	FC-75-MPC-006 (50 per bag)	Seals the surface-mount component to the substrate and manifold	Fluorocarbon FKM (75 durometer)
		KZ-7075-OR-006 (quantity of 1)		Kalrez 7075 compound

Mounting Blocks

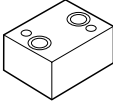
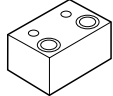
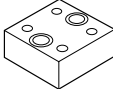
Item	Description	Ordering Number	Function	Material
	Support	A-MPC-MH-SPRT	Bolts to the bottom of a substrate channel to provide midline support to a channel with five or more surface-mount positions	Aluminum alloy 2024-T351
	Foot	A-MPC-MH-FOOT	Bolts to each end of the substrate channel to provide mounting capability to the base plate	
	Spacer foot	A-MPC-MH-SPCR	Bolts two inline substrates together to maintain standard surface-mount spacing	

Assembly Hardware

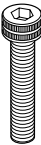
Item	Description	Ordering Number	Function	Material
	Lockdown bar	SS-MPC-MH-LBAR	Holds down the substrate components at each end of the substrate channel	300 series stainless steel
	Hex socket cap screw, 10-32 × 0.50 in.	SS-MPC-MH-0500 (20 per bag)	Secures the substrate assembly to the manifold assembly and secures the surface-mount component to the substrate assembly	316 series stainless steel
	Hex socket cap screw, 10-32 × 1.00 in.	SS-MPC-MH-1000 (10 per bag)	Secures the substrate assembly to the foot	

Safe Product Selection

When selecting a product, the total system design must be considered to ensure safe, trouble-free performance.

Function, material compatibility, adequate ratings, proper installation, operation, and maintenance are the responsibilities of the system designer and user.

Warranty Information

Swagelok products are backed by The Swagelok Limited Lifetime Warranty. For a copy, visit swagelok.com or contact your authorized Swagelok representative.

Swagelok—TM Swagelok Company
Microsoft, Windows—TM Microsoft Corp.
AutoCAD—TM Autodesk, Inc.
SolidWorks—TM SolidWorks Corporation
Kalrez—TM DuPont
Simriz—TM Freudenberg-NOK
picofast—TM Hans Turck KG
DeviceNet—TM ODVA
© 2007–2014 Swagelok Company
Printed in U.S.A., AGS
April 2014, R12
MS-02-185